

COMPRESSIVE CREEP AND RECOVERY BEHAVIORS OF SEAT CUSHIONS IN UPHOLSTERED FURNITURE

Wei Xu

Associate Professor
E-mail: xuwei@njfu.edu.cn

Zhihui Wu

Professor
College of Furniture and Industrial Design
Nanjing Forestry University
Nanjing, China
E-mail: wzh550@sina.com

*Jilei Zhang**†

Professor
Department of Sustainable Bioproducts
Mississippi State University
Mississippi State, MS
E-mail: jz27@msstate.edu

(Received April 2015)

Abstract. This study investigated effects of compressive load magnitude and cover and core materials on the force-deformation-time behavior of seat cushions commonly used in upholstered furniture. Results indicated that the Burger and Kelvin models could be used to describe the creep and recovery behavior of a furniture seat cushioning system composed of foam, spring, and cover materials, respectively. Statistical analyses of experimental data indicated that the magnitude of creep loads had significant effects on the viscoelastic constants in mathematical expressions derived from the Burger model for describing the force-deformation-time behavior of the cushions evaluated. Foam cushions with coil springs had significantly greater viscoelastic constants than those without. Changing cushion cover material from leather to fabric had no significant effect on the elastic constant of tested cushion materials, but increased the viscous constant and delayed elastic-deformation-related damping constants.

Keywords: Creep, recovery, Burger model, Kelvin model, polyurethane foam, viscoelastic composite, compression, spring, fabric, leather, upholstered furniture.

INTRODUCTION

Creep, defined as the time-dependent deformation phenomena exhibited by a material under sustained loading for extended periods (Bodig and Jayne 1982), commonly occurs in an upholstered furniture seat foundation system. A seat foundation system is mainly composed of a seat cushioning system, which consists of polyurethane foam, springs (coil or zig-zag type), and cover materials (fabric, leather, etc.), and a structural

frame system supporting the cushioning system. Even under lower magnitude loading, creep can cause permanent and nonrecoverable deformation and elastic property changes to the seat foundation system, especially to the seat cushioning system, which provides users with sitting comfort experience. Results of gradually developed, nonrecoverable deformation and compressive modulus to spring, foam, and cover materials caused by creep with time can eventually affect visual and functional performance of an upholstered furniture seating system. Examples of this include cover material bagging, less total vertical motion (sometimes called “ride”), loss

* Corresponding author

† SWST member

of firmness during use, foam “bottoming out” (allowing one to feel the spring or deck construction of a seat foundation system), and lower seat cushion surface resilience. Therefore, understanding the time-dependent deformation behavior of the seat cushioning system of upholstered furniture can be useful in developing mathematical models containing viscoelastic constants for interpreting and predicting material creep behavior. This information can be used to guide the seating aesthetics, comfort, and durability design of upholstered furniture.

The creep behavior of a viscoelastic material can be described with the Burger model (Bodig and Jayne 1982) to account for its elastic, delayed elastic, and viscous behaviors. The Kelvin model is used for prediction of the deformation recovery behavior of crept materials. Very limited literature was found for creep behavior of the seat cushioning system as a viscoelastic composite in upholstery furniture application. Most studies focused on the compressive creep and recovery behavior of polymer foams based on the modeling of their microstructure, ie cell geometry of their foams (Zhu and Mills 1999; Izzard et al 2012) made of a matrix material (polymer) and cells (gas). This is because foams can exhibit dramatically different properties, depending on the matrix material as well as cell microstructure.

The main objective of this study was to investigate creep behavior of the seat cushioning system commonly used in upholstered furniture with the intention of proposing a mathematical model to represent the force-deformation-time behavior of the furniture seat cushioning system. Specific objectives were to 1) use the Burger model to describe the creep behavior of spring-foam-cover type cushions subjected to compressive loads, 2) use the Kelvin model to describe the creep recovery behavior of spring-foam-cover type cushions, 3) derive mathematical equations for estimating creep and recovery deformations, 4) evaluate effects of creep loading level, cover material type, and cushion interior material type on viscoelastic constants of derived empirical equations, and 5) compare

performances among evaluated cushions based on derived viscoelastic constants.

MATERIALS AND METHODS

Experimental Design

Figure 1 shows the dimensions and exterior and interior components of two typical cushion samples evaluated in this study. Foam was made of polyurethane with a density of 27 kg/m^3 . The bagged-coil-type interior springs (seven rows and seven columns) with 60 mm diameters and 120 mm pitches were made of 2-mm-diameter carbon steel wires. One cover material was genuine leather and the other was 100% cotton fabric.

A complete $3 \times 2 \times 2$ factorial experiment with three cushion replicates was conducted to evaluate the factors of compressive creep and the recovery behaviors of cushions commonly used in upholstered furniture seat cushioning systems. The three factors were creep load level (250, 600, 1000 N), cover material type (leather, fabric), and interior material type (foam only, foam with coil springs). The constant creep loading duration was

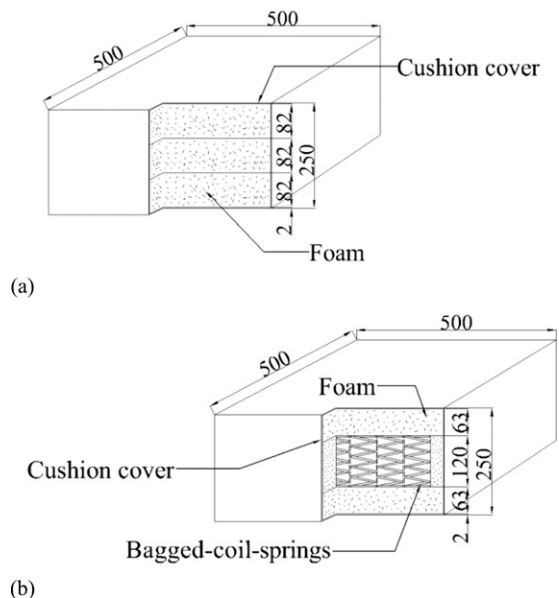

Figure 1. Dimensions and material components of cushion samples evaluated in this study: (a) foam only and (b) foam with coil springs.

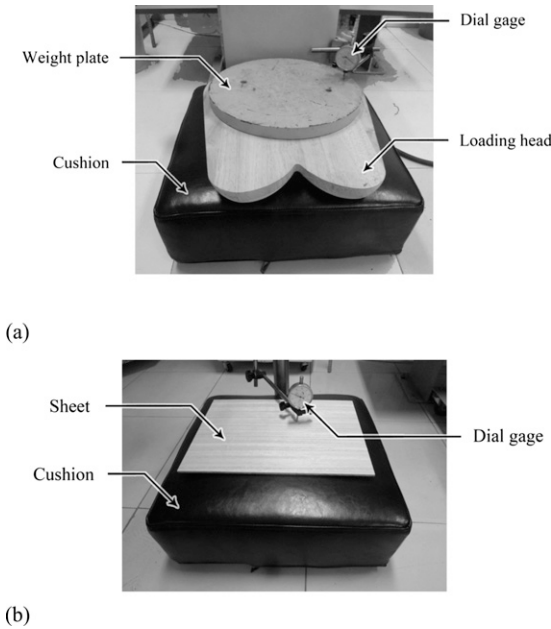

Figure 2. Test set-ups for evaluating compressive creep (a) and recovery (b) of cushion samples.

24 h for all testing load levels (CNS 2008). The recovery time after the creep load release was 24 h for each of 12 experimental combinations.

Testing

Figure 2 shows the set-ups for deformation measurement during cushion creeping and recovery. A cushion sample was compressed vertically using the loading head together with a weight plate added on. Figure 3 shows the shape and dimension of a creep test loading head fabri-

cated in reference to the standards of BS (2000) and CNS (1989). Both compression and recovery testing were performed in a room with its temperature and RH controlled at 25–29°C and 60–70%, respectively.

Because of large deformation at the beginning of testing, the instantaneous deformations of the first 30 min were measured at 5-min intervals using a straightedge and a dial indicator. After that, deformation was measured using a 10-mm range dial gage at 10-min intervals. After the creep load was removed, creep recovery deformation was measured for 24 h. During the cushion recovery period, a dial gage (Fig 2b) measured the recovery of unloaded cushion samples at every 5-min intervals at the beginning. After 30 min, recovery was measured at every 30-min intervals. A paulownia sheet (30 × 40 × 5 mm) with negligible weight was placed levelly on the top of a cushion sample to facilitate measurement of cushion recovery.

RESULTS AND DISCUSSION

Figure 4 shows typical creep and recovery curves of the four types of cushions evaluated in this study. Two distinct stages of deformation can be identified from creep curve sections: primary and secondary (Bodig and Jayne 1982). However, there was not a tertiary stage. Table 1 summarizes mean values of elastic, total, and viscous deformations measured during creep and recovery processes of

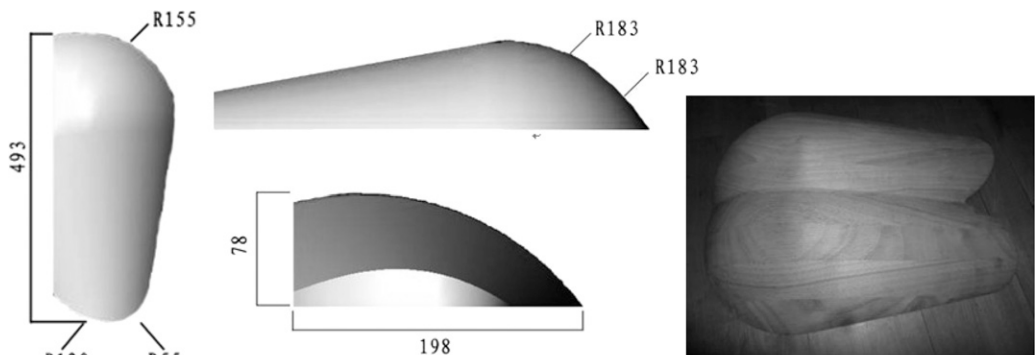

Figure 3. Shape and sizes of the loading head used in this study.

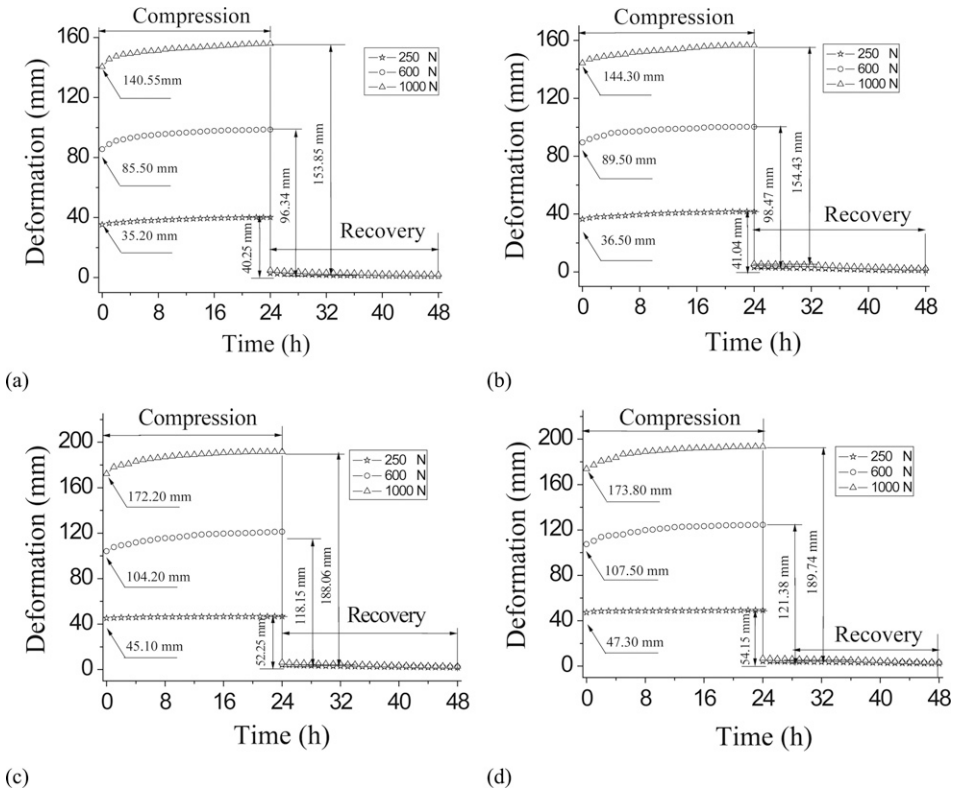

Figure 4. Typical creep and recovery curves of tested cushions: (a) Spring-foam/leather, (b) Spring-foam/fabric, (c) foam/fabric, and (d) foam/leather.

Table 1. Mean values of elastic, total, and viscous deformations measured during creep and recovery processes of four types of cushions subjected to three compressive load levels.^a

Cover material type	Interior material type	Load level (N)	Deformation		
			Elastic (mm)	Total (mm)	Viscous (mm)
Leather	Spring-foam	250	35.2 (4.3)	41.1 (6.3)	0.87 (2.9)
		600	85.5 (6.8)	97.7 (2.7)	1.36 (5.1)
		1000	140.6 (3.7)	155.9 (4.9)	2.05 (3.8)
Fabric	Spring-foam	250	36.5 (9.5)	42.1 (7.4)	1.06 (5.3)
		600	89.5 (8.4)	100.3 (6.0)	1.83 (3.2)
		1000	144.3 (2.8)	156.6 (4.9)	2.17 (4.3)
Leather	Foam	250	45.1 (6.7)	54.0 (5.2)	1.75 (4.9)
		600	104.2 (7.5)	121.2 (7.2)	3.05 (2.2)
		1000	172.2 (6.2)	191.6 (6.4)	3.54 (3.6)
Fabric	Foam	250	47.3 (3.2)	56.3 (3.9)	2.15 (2.8)
		600	107.5 (5.4)	124.5 (8.5)	3.12 (5.7)
		1000	173.8 (9.1)	193.5 (6.4)	3.76 (3.8)

^a Values in parentheses are coefficients of variation in percentage.

four cushion groups. Elastic deformation is the instantaneous deformation measured at the time of testing load application. It recovers instantaneously after the applied load is removed.

Total deformation is the sum of elastic, delayed elastic, and viscous deformations. Delayed elastic deformation is time dependent and recoverable. Viscous deformation is permanent and

nonrecoverable. Each value in Table 1 is a mean of three replicates.

Creep Behavior Modeling

The following force-deformation-time expression using the Burger model (Bodig and Jayne 1982) was proposed to describe the creep behavior of cushions evaluated in this study:

$$\mu = p \left[\frac{1}{k_e} + \frac{1}{k_{de}} \left(1 - e^{-\left(\frac{k_{de}}{r_{de}}\right)t} \right) + \frac{t}{r_v} \right] \quad (1)$$

where μ is the creep deformation (mm); p is the creep load (N); t is the creep time (h); k_e and r_v refer to the elements in Maxwell’s model accounting for the elastic and viscous behaviors of a tested material, ie k_e is the elastic constant related to the instantaneous elastic deformation (N/mm) and r_v is the damping constant related to the viscous deformation proportional to the load and time, which is permanent and non-recoverable (N-h/mm); k_{de} and r_{de} refer to the elements in Kelvin’s model accounting for the delayed elastic behavior of a tested material, ie k_{de} is the delayed elastic constant (N/mm) and r_{de} is the damping constant (N-h/mm), and both are related to delayed elastic deformation, which is time dependent and recoverable.

The force-deformation-time expression (Eq 1) indicates that the greater the value of an elastic constant k_e or delayed elastic constant k_{de} of a time-dependent material, the more force is

required for deforming the material. The greater the value of a damping constant r_{de} of a time-dependent material, the longer the time it will take to deform the material and recover compressed recoverable deformation during creep. If the r_v value is greater, less permanent deformation will result for a given creep load level and period.

The following equation was used to fit individual data points for each of three creep curves recorded for each combination of cover material type by interior material type by load level using the least squares regression method. Therefore, the estimated constants of k_e , k_{de} , r_{de} , and r_v for each of 12 equations describing creep behavior of four types of cushions subjected to three creep loads were obtained:

$$y = a + b(1 - e^{-ct}) + dt \quad (2)$$

where y is the creep deformation measured (mm); t is the creep time (h); a , b , c , and d are the regression fitting constants.

Table 2 summarizes regression fitting constants and coefficients of determination r^2 of the derived 12 equations for describing creep behavior of four types of cushions subjected to three creep loads. High r^2 values indicated that Burger’s model fit well to the experimental data of this force-deformation-time creep study. This suggests that Burger’s model could be used to describe the creep behavior of cushions evaluated in this study. Table 3 summarizes mean values of viscoelastic constants k_e , k_{de} , r_{de} , and r_v derived based on the

Table 2. Mean values of derived regression constants and their associated r^2 values of 12 equations estimating creep behavior of four cushion types subjected to three load levels.^a

Cover material type	Interior material type	Load (N)	<i>a</i>	<i>b</i>	<i>c</i>	<i>d</i>	r^2
Leather	Spring-foam	250	35.311 (3.9)	5.05 (6.5)	0.281 (7.4)	0.036 (4.2)	0.934
		600	88.626 (6.2)	10.830 (9.1)	0.295 (5.5)	0.057 (5.2)	0.912
		1000	140.253 (5.7)	13.245 (4.4)	0.622 (4.1)	0.085 (3.8)	0.942
Fabric	Spring-foam	250	36.496 (2.8)	4.521 (4.5)	0.387 (6.5)	0.044 (6.3)	0.957
		600	89.955 (4.7)	8.969 (5.7)	0.437 (4.8)	0.076 (8.4)	0.914
		1000	144.509 (8.2)	10.132 (8.3)	0.966 (5.5)	0.090 (9.1)	0.916
Leather	Foam	250	47.259 (4.9)	7.143 (8.7)	0.298 (7.6)	0.073 (8.8)	0.933
		600	109.689 (7.4)	13.953 (4.9)	0.348 (6.6)	0.127 (6.4)	0.927
		1000	175.439 (4.8)	15.848 (2.6)	0.641 (7.1)	0.147 (2.7)	0.917
Fabric	Foam	250	45.126 (2.5)	6.831 (5.3)	0.315 (5.7)	0.090 (5.5)	0.954
		600	106.762 (5.3)	13.889 (7.3)	0.360 (6.1)	0.130 (8.3)	0.931
		1000	173.611 (7.1)	15.949 (8.4)	0.695 (3.5)	0.157 (7.3)	0.905

^a Values in parentheses are coefficients of variation in percentage.

Table 3. Mean values of derived viscoelastic constants of 12 empirical equations based on Burger model for estimating creep behavior of four types of cushions subjected to three load levels.^a

Cover material type	Interior material type	Load (N)	k_c (N/mm)	k_{de} (N/mm)	r_v (N-h/mm)	r_{de} (N-h/mm)
Leather	Spring-foam	250	7.08 (1.3)	49.5 (6.3)	6869 (4.7)	176.2 (5.3)
		600	6.77 (3.5)	55.4 (9.2)	10,588 (6.3)	187.8 (5.8)
		1000	7.13 (1.1)	75.5 (5.9)	11,707 (5.8)	121.4 (9.7)
Fabric	Spring-foam	250	6.85 (2.7)	55.3 (3.1)	5660 (4.4)	142.9 (6.4)
		600	6.67 (2.1)	66.9 (5.9)	7876 (5.3)	153.1 (9.1)
		1000	6.92 (1.9)	98.7 (2.7)	11,060 (4.5)	102.2 (4.7)
Leather	Foam	250	5.29 (1.3)	35.0 (2.8)	3429 (8.7)	117.4 (3.9)
		600	5.47 (2.6)	43.0 (7.3)	4721 (4.8)	123.6 (8.9)
		1000	5.70 (2.9)	63.1 (5.8)	6779 (4.5)	98.4 (5.4)
Fabric	Foam	250	5.54 (1.1)	36.6 (3.6)	2791 (8.1)	116.2 (7.4)
		600	5.62 (1.2)	43.2 (4.6)	4615 (5.0)	120.0 (9.8)
		1000	5.76 (3.5)	62.7 (4.5)	6383 (5.2)	90.2 (7.7)

^a Values in parentheses are coefficients of variation in percentage.

regression constants for each of the 12 equations. Each value represents a mean of three values obtained from three derived empirical equations.

Prediction of Delayed Elastic and Viscous Deformations

The 12 derived equations (Table 3) were used to predict delayed elastic and viscous deformations that occurred at the end of a 24-h recovery period (Fig 4) for each of 12 situations, respectively. Table 4 shows the differences between predicted and observed values for delayed elastic and viscous deformations, respectively. The differences were expressed as a percentage of predicted values. Each observed delayed elastic deforma-

tion in Table 4 was calculated from the deduction of its corresponding elastic and viscous deformations from its corresponding total deformation in Table 1. Mean differences between predicted and observed values differed less than 1% for the results of both delayed elastic and viscous deformations. This further suggested that the derived equations based on Burger's model can be used to describe the creep behavior of cushion types used in this study.

Creep Recovery Behavior Modeling

The following force-deformation-time equation derived from the Kelvin model (Bodig and Jayne 1982) was proposed to describe the creep

Table 4. Comparison of observed delayed elastic and viscous deformations with their corresponding ones predicted with derived empirical equations based on Burger model.

Cover material type	Interior material type	Load (N)	Delayed elastic deformation			Viscous deformation		
			Observed (mm)	Predicted (mm)	Difference (%)	Observed (mm)	Predicted (mm)	Difference (%)
Leather	Spring-foam	250	4.90	5.05	3.06	0.90	0.86	-4.00
		600	10.90	10.84	-0.55	1.40	1.37	-2.29
		1000	13.00	13.25	1.92	2.00	2.04	2.00
Fabric	Spring-foam	250	4.60	4.52	-1.74	1.00	1.06	5.60
		600	9.10	8.97	-1.43	1.80	1.82	1.33
		1000	10.00	10.13	1.30	2.20	2.16	-2.26
Leather	Foam	250	7.00	7.14	2.00	1.80	1.75	-2.67
		600	14.20	13.95	-1.76	3.00	3.05	1.60
		1000	15.70	15.85	0.96	3.40	3.53	3.76
Fabric	Foam	250	6.90	6.83	-1.01	2.10	2.16	2.86
		600	13.70	13.89	1.39	3.00	3.12	4.00
		1000	16.20	15.95	-1.54	3.80	3.77	-0.84

recovery behavior of cushions evaluated in this study, starting from the instant removal of the creep load p , which was applied to the cushions for 24 h:

$$\mu = \frac{P}{k_{de}} (1 - e^{-24}) e^{-\left(\frac{k_{de}}{r_{de}}\right)t} \quad (3)$$

where μ is the creep recovery deformation (mm); p is the creep load removed (N); t is the recovery time measured from the instant the creep load was removed (h); k_{de} is the delayed elastic constant (N/mm); and r_{de} is the damping constant related to delayed elastic deformation (N-h/mm).

The following equation was used to fit individual data points for each of three creep recovery curves recorded for each combination of cover material type by interior material type by load level using the least squares regression method:

$$y = a(1 - e^{-24})e^{-bt} \quad (4)$$

where y is the creep recovery deformation measured (mm); t is the creep recovery time (h); and a and b are the regression fitting constants.

Therefore, estimated constants k_{de} and r_{de} for each of 12 equations describing creep recovery behavior of four types of cushions were obtained using the relations $k_{de} = p/a$ and $r_{de} = p/ab$. Table 5 summarizes mean values of regression

fitting constants and their corresponding coefficients of determination r^2 for each of the 12 equations, and also derived delayed elastic constants based on these regression constants. High r^2 values indicated that the Kelvin model fits well to the experimental data of creep recovery curves of cushion materials evaluated in this study. This suggests that the Kelvin model could be used to describe the creep recovery behavior of spring-foam-type cushions.

Table 6 summarizes mean differences between delayed elastic constants k_{de} and r_{de} , derived from creep and recovery curves, respectively. The differences were expressed as a percentage of the constants from recovery curves. The differences between delayed elastic constants from creep and recovery curves were less than 15.8% for k_{de} and 8.3% for r_{de} . In general, the delayed elastic constants from recovery curves were greater than that from creep curves. Cumulative damages to cushion materials during the creep process caused the delayed recovery ability to be decreased, which in turn caused the lower values of delayed elastic constants derived from creep recovery curves.

Mean Comparisons of Viscoelastic Constants

A three-factor analysis of variance (ANOVA) general linear model (GLM) procedure was performed first for each of four viscoelastic

Table 5. Mean values of delayed recovery constants derived from regression constants and their associated r^2 for 12 equations based on the Kelvin model and used for estimating creep recovery behavior of four cushion types subjected to three load levels in this study.^a

Cover	Interior	Load (N)	Regression constants			Delayed recovery constants	
			a	b	r^2	k_{de} (N/mm)	r_{de} (N-h/mm)
Leather	Spring-foam	250	4.33 (8.5)	0.32 (5.4)	0.927	57.7 (6.7)	177.8 (7.5)
		600	9.12 (4.6)	0.34 (6.6)	0.943	65.8 (7.5)	195.5 (5.3)
		1000	12.12 (6.7)	0.64 (4.5)	0.902	82.5 (8.4)	128.7 (7.7)
Fabric	Spring-foam	250	4.11 (5.8)	0.41 (6.3)	0.873	60.8 (6.5)	149.5 (9.2)
		600	8.20 (6.9)	0.47 (8.7)	0.942	73.2 (8.8)	156.7 (6.5)
		1000	9.39 (7.0)	0.97 (4.4)	0.911	106.5 (4.7)	110.3 (3.8)
Leather	Foam	250	6.14 (7.3)	0.32 (4.7)	0.885	40.7 (3.6)	126.5 (7.2)
		600	12.68 (8.2)	0.36 (7.5)	0.962	47.3 (9.5)	130.6 (4.1)
		1000	14.20 (6.5)	0.68 (8.8)	0.896	70.4 (7.8)	103.8 (6.6)
Fabric	Foam	250	6.22 (3.8)	0.33 (3.7)	0.944	40.2 (8.9)	121.3 (6.8)
		600	12.32 (5.7)	0.38 (9.9)	0.912	48.7 (6.7)	127.5 (8.4)
		1000	14.60 (9.1)	0.70 (4.6)	0.903	68.5 (8.4)	98.5 (9.5)

^a Values in parentheses are coefficients of variation in percentage.

Table 6. Comparison of delayed elastic and damping constants derived from creep and recovery curves.

Cover material type	Interior material type	Load (N)	k_{de}			r_{de}		
			Recovery (N/mm)	Creep (N/mm)	Difference (%)	Recovery (N-h/mm)	Creep (N-h/mm)	Difference (%)
Leather	Spring-foam	250	57.7	49.5	14.2	177.8	176.2	0.9
		600	65.8	55.4	15.8	195.5	187.8	3.9
		1000	82.5	75.5	8.5	128.7	121.4	5.7
Fabric	Spring-foam	250	60.8	55.3	9.0	149.5	142.9	4.4
		600	73.2	66.9	8.6	156.7	153.1	2.3
		1000	106.5	98.7	7.3	110.3	102.2	7.3
Leather	Foam	250	40.7	35.0	14.0	126.5	117.4	7.2
		600	47.3	43.0	9.1	130.6	123.6	5.4
		1000	70.4	63.1	10.4	103.8	98.4	5.2
Fabric	Foam	250	40.2	36.6	9.0	121.3	116.2	4.2
		600	48.7	43.2	11.3	127.5	120.0	5.9
		1000	68.5	62.7	8.5	98.5	90.2	8.4

constants to analyze three main effects (load level, cover material type, interior material type) and their interactions on four viscoelastic constants, followed by mean comparisons using the protected least significant difference (LSD) multiple comparisons procedure if any significant interaction was identified. Otherwise main effects were concluded. All statistical analyses were performed at the 5% significance level. Table 7 summarizes ANOVA results obtained from the GLM procedure performed for each of four viscoelastic constants.

For the elastic constant, k_e , ANOVA results indicated that cover material type had a p value of 0.8201, which was considered statistically nonsignificant. Mean comparison of main effects indicated that cover material type had no significant effect on the elastic constant of evaluated cushions. Main effects of interior material type and load level were all considered statisti-

cally significant at the 5% level. Further checking the magnitudes of their F values (Table 7) indicated that interior material type had a much larger F value of 534 than load level with an F value of 6.46. This could be interpreted to mean that the significance of interior material type effect on the elastic constant was much stronger than the load level. Therefore, the interior material type effect on the elastic constant was performed based on mean comparisons of the main effect directly. The comparison result indicated that foam cushions with coil springs had a significantly greater elastic constant than those without springs. The load level effect on the elastic constant was analyzed by considering the nonsignificant three-way interaction (with a p value of 0.6538) because the nature of conclusions from interpretation of main effects also depends on the relative magnitudes of the interaction and individual main effects (Freund and Wilson 1997). Mean comparison results of elastic constants for load levels

Table 7. Summary of analysis of variance (ANOVA) results obtained from the general linear model (GLM) procedure performed on three factors for each of four viscoelastic constants.

Source	Elastic constant							
	k_e		k_{de}		r_v		r_{de}	
	F value	p value	F value	p value	F value	p value	F value	p value
Cover	0.05	0.8201	32.17	<0.0001	117	<0.0001	15.27	0.0007
Interior	534	<0.001	254	<0.0001	2187	<0.0001	72.19	<0.0001
Cover \times interior	8.15	0.0087	28.02	<0.0001	43.11	<0.0001	8.37	0.0080
Load	6.46	0.0057	226	<0.0001	758	<0.0001	38.37	<0.0001
Cover \times load	0.29	0.7536	3.45	0.0481	8.18	0.0020	0.14	0.8708
Interior \times load	3.54	0.0450	3.60	0.0430	30.86	<0.0001	5.01	0.0152
Cover \times interior \times load	0.43	0.6538	5.30	0.0124	16.39	<0.0001	0.65	0.5328

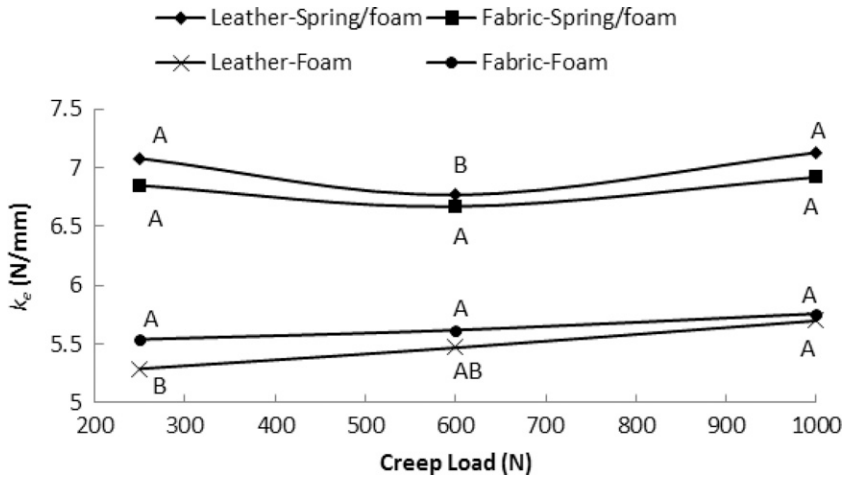

Figure 5. Mean comparisons of elastic constants, k_e , for load level within each combination of interior material type by cover material type.

within each combination of interior material type by cover material type are summarized in Fig 5. The results were based on a one-way classification with 12 treatment combinations with respect to the three-factor interaction and mean comparisons among these combinations using a single LSD value of 0.29 N/mm. In addition, mean comparisons of the elastic constant based on the three-way interaction for each of the other two main effects, cover material type and interior material type, yielded the same results obtained from mean comparisons with respect to main effects.

For the delayed elastic constant, k_{de} , ANOVA results (Table 7) indicated that all three main effects were significant, but relative magnitudes of these main effects were different. Cover material type had a much lower F value (32.17) compared with interior material type (F value of 254) and load level (F value of 229). Therefore, effects of interior material type and load level on the delayed elastic constant were performed separately based on their mean comparisons. Mean comparisons of interior material type indicated that foam cushions with coil springs had a significantly greater delayed elastic constant than those without springs. Mean comparisons of load levels indicated that cushions subjected to a 1000-N load had a significantly greater

delayed elastic constant than the other two load levels, followed by 600-N loaded cushions, then 250-N loaded cushions (Fig 6). The relatively weak effect of cover material on the delayed elastic constant was analyzed by considering the marginally significant three-way interaction (Table 7). Table 8 summarizes mean comparisons of the delayed elastic constants for cover material type within each combination of load level by interior material type. The results were based on a one-way classification with 12 treatment combinations with respect to the three-factor interaction and mean comparisons among these combinations using a single LSD value of 6.2 N/mm. Meanwhile, mean comparisons of the delayed elastic constant based on the three-way interaction for each of the other two main effects, load level and interior material type, also yielded the same results from mean comparisons with respect to main effects only.

For the damping constant, r_v , which is related to viscous deformation, ANOVA results (Table 7) indicated that the three-way interaction was significant. This suggested that further analyses should be focused on the significant interaction. In addition, three main effects were all significant with their p values less than 0.0001. Further checking F values of these significant main effects found that their relative magnitudes were different.

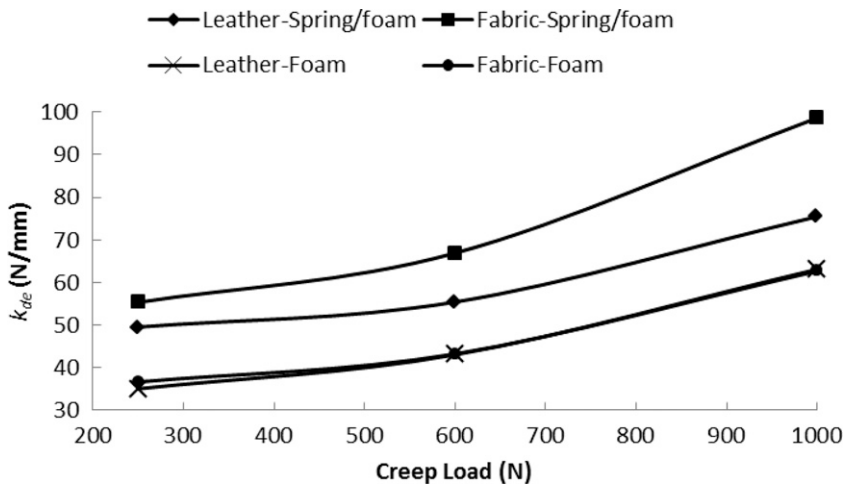

Figure 6. Mean comparisons of delayed elastic constants, k_{de} , for load level within each combination of interior material type by cover material type.

Table 8. Mean comparisons of delayed elastic constants, k_{de} , for cover material type within each combination of load level by interior material type.

Load level (N)	Interior material type	Cover material type ^a	
		Leather (N/mm)	Fabric (N/mm)
250	Spring-foam	49.5 A	55.3 A
	Foam	35.0 A	36.6 A
600	Spring-foam	55.4 B	66.9 A
	Foam	43.0 A	43.2 A
1000	Spring-foam	75.5 B	98.7 A
	Foam	63.1 A	62.7 A

^a Means not followed by a common letter are significantly different one from another at $p = 0.05$ level.

Interior material type and load level had much greater F values of 2188 and 758, respectively, than cover material type with an F value of 117. Therefore, interpretation of interior material type and load level effects on the damping constant was based on their mean comparisons, respectively, because of the much greater magnitude of their F values. Mean comparison of interior material type indicated that foam cushions with coil springs had a significantly greater damping constant than those without springs. Mean comparisons of load level indicated that cushions subjected to a 1000-N load exhibited a significantly greater damping constant than the other two load levels, followed by 600-N loaded cushions, then 250-N loaded cushions (Fig 7). The

cover material type effect was analyzed by considering the three-way interaction. Table 9 summarizes mean comparisons of damping constants for cover material type within each combination of load level by interior material type. The results were based on a one-way classification with 12 treatment combinations with respect to the three-factor interaction and mean comparisons among these combinations using a single LSD value of 453 N-h/mm. Meanwhile, mean comparisons of the damping constant based on the three-way interaction for each of the other two main effects, interior material type and load level, yielded the same results from mean comparisons with respect to main effects only.

For the damping constant r_{de} , which is related to delayed elastic deformation, ANOVA results (Table 7) indicated that although three main effects were significant based on their p values, their corresponding F values were relatively low (less than 100). Therefore, their effects on the damping constant were analyzed by considering the three-way interaction, although it was not significant. Mean comparison results are summarized in Fig 8 for load level and in Tables 10 and 11 for interior material type and cover material type, respectively. The results were based on a one-way classification with 12 treatment combinations with respect to the three-factor interaction

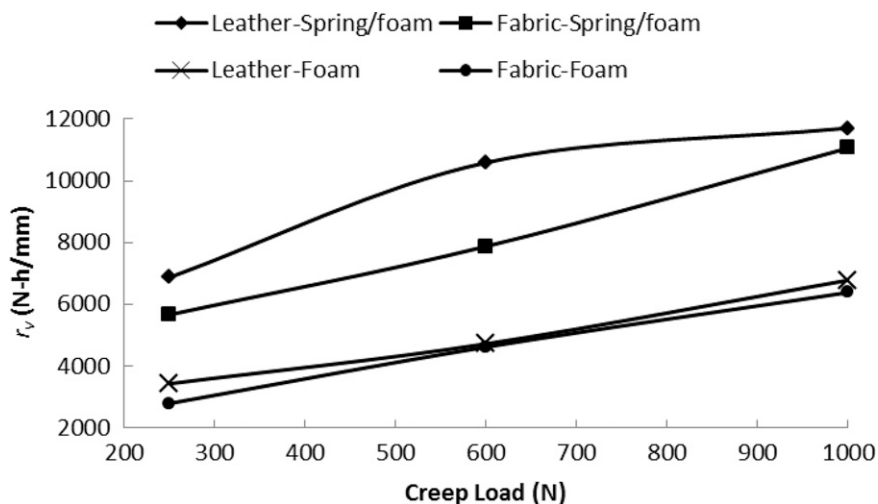

Figure 7. Mean comparisons of damping constants, r_v , related to viscous deformation, for load level within each combination of interior material type by cover material type.

Table 9. Mean comparisons of damping constants, r_v , related to viscous deformation for cover material type within each combination of load level by interior material type.

Load level (N)	Interior material type	Cover material type ^a	
		Leather (N-h/mm)	Fabric (N-h/mm)
250	Spring-foam	6869 A	5660 B
	Foam	3429 A	2791 B
600	Spring-foam	10,588 A	7876 B
	Foam	4721 A	4615 A
1000	Spring-foam	11,707 A	11,060 B
	Foam	6779 A	6383 A

^a Means not followed by a common letter are significantly different one from another at $p = 0.05$ level.

and mean comparisons among these combinations using a single LSD value of 21.6 N-h/mm.

Load level effects. Statistical analysis results indicated that creep load level had influences on the magnitude of four viscoelastic constants of cushions evaluated in this study. For foam cushions without coil springs, their elastic constants tended to increase as creep loads increased from 250 to 1000 (Fig 5). This increase was not significant for cushions covered with fabric, but became significant when these cushions were covered with leather. Foam cushions with coil springs tended to exhibit lower elastic constants when they were subjected to a 600-N load compared with the same type of foam cushions sub-

jected to a 250- or 1000-N load. This lower elastic constant situation was not significant if fabric covers were used but became significant when leather covers were used. Foam cushions with coil springs tended to show greater elastic constants when subjected to the 1000-N load than when subjected to the 250-N load, but this trend was not significant (Fig 5). In general, creep loading levels did not significantly influence elastic constants of fabric-covered foam cushions with or without coil springs.

The delayed elastic constant, k_{de} , and damping constant, r_v , exhibited a significant increasing trend as creep load increased from one level to the next (Figs 6 and 7). Figure 6 shows that increasing rates of delayed elastic constants are greater when the load increased from 600 to 1000 N compared with the load increasing from 250 to 600 N. For the damping constant, r_v (Fig 7), the increasing rate in general is constant as creep load increased from 250 to 1000 N. This was not the case for spring-foam cushions covered with leather for which the rate decreased as creep load increased from 600 to 1000 N.

The damping constant, r_{de} , showed a significant decrease (Fig 8) as creep load increased from 600 to 1000 N, and in this load range, cushions with coil springs tended to show a

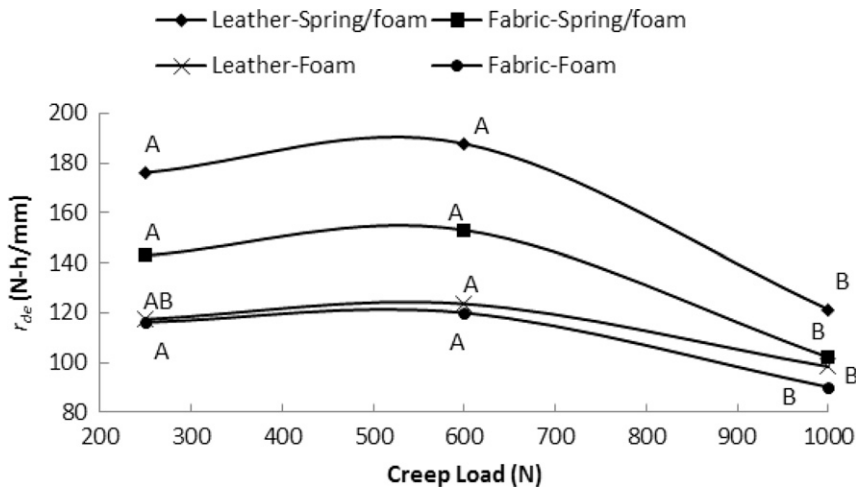

Figure 8. Mean comparisons of damping constants, r_{de} , related to delayed elastic deformation, for load level within each combination of interior material type by cover material type.

Table 10. Mean comparisons of damping constants, r_{de} , related to delayed elastic deformation, for interior material type within each combination of load level by cover material type.

Load level (N)	Cover material type	Interior material type ^a	
		Spring-foam (N-h/mm)	Foam (N-h/mm)
250	Leather	176.2 A	117.4 B
	Fabric	142.9 A	116.2 B
600	Leather	187.8 A	123.6 B
	Fabric	153.1 A	120.0 B
1000	Leather	121.4 A	98.4 B
	Fabric	102.2 A	90.2 A

^a Means not followed by a common letter are significantly different one from another at $p = 0.05$ level.

Table 11. Mean comparisons of damping constants, r_{de} , related to delayed elastic constant for cover material type within each combination of load level by interior material type.

Load level (N)	Interior material type	Cover material type ^a	
		Leather (N-h/mm)	Fabric (N-h/mm)
250	Spring-foam	176.2 A	142.9 B
	Foam	117.4 A	116.2 A
600	Spring-foam	187.8 A	153.1 B
	Foam	123.6 A	120.0 A
1000	Spring-foam	121.4 A	102.2 A
	Foam	98.4 A	90.2 A

^a Means not followed by a common letter are significantly different one from another at $p = 0.05$ level.

more significant decrease in rate compared with those without coil springs. As creep load increased from 250 to 600 N, the damping constant increased but it was not significant.

These results might indicate that the viscoelastic constants used to describe the creep behavior of cushion materials can be altered after these cushion materials are subjected to creeping loads. Delayed elastic constants and damping constants related to viscous deformation can be increased. The damping constant related to delayed elastic deformation of cushions can be altered to lower values after being loaded with a greater magnitude of creep load. The elastic constant does not appear to be very sensitive to creep load change.

Interior material type effects. Statistical analysis results indicated that the interior material type had significant influences on the magnitude of four viscoelastic constants of cushions evaluated in this study. In general, foam cushions with coil springs had significantly greater viscoelastic constants than those without. This indicates that it will take more load to deform foam cushions with coil springs than those without coil springs. Cushions with coil springs will deform more slowly under creep loads and recover more slowly when the creep load is released than those without. Cushions with coil springs have a less permanent and nonrecoverable deformation than those without.

Cover material type effects. Table 3 indicates that foam cushions with coil springs, if covered with leather, will yield a greater elastic constant than those covered with fabric. For cushions without coil springs, fabric-covered specimens yielded a greater elastic constant than leather-covered ones. But statistical analysis results indicated that these highs or lows of elastic constants caused by cover material type change were not significant for cushion specimens evaluated in this study. This indicates that elastic deformation and recovery of cushions evaluated in this study were not sensitive to cover material changes.

Table 8 indicates that cushions covered with fabric showed a greater delayed elastic constant, k_{de} , than those with leather. These differences were not significant for foam cushions without coil springs. In the case of foam cushions with coil springs, the difference became significant as the creep load increased to 600 N and greater. This might imply that it takes greater loads to deform the fabric-covered cushions than the leather-covered ones during the creep process.

Table 9 indicates that cushions covered with leather had a greater damping constant, r_v , than those covered with fabric. These differences were significant for foam cushions with coil springs. In the case of foam cushions without coil springs, the difference became less significant as the creep load increased to 600 N and greater. These results indicated that cushions covered with leather tended to recover more from deformation than those covered with fabric, ie leather-covered cushions will had less permanent and nonrecoverable deformation than those covered with fabric. Furthermore, coil spring-foam cushions covered with leather had significantly less permanent and nonrecoverable deformation than those covered with fabric.

Table 11 indicates that cushions covered with leather had a greater damping constant, r_{de} , than those covered with fabric. These differences were not significant for foam cushions without coil springs. In the case of foam cushions with coil springs, the difference was significant when creep

load was 600 N and less and became insignificant as creep load increased to 1000 N. The greater damping constant indicated that cushions covered with leather tended to deform more slowly than those covered with fabric under creep loads and recovered more slowly than fabric-covered cushions after creep load was removed.

CONCLUSIONS

Effects of seat cushion materials and the magnitude of creep loads on the force-deformation-time behavior of typically used furniture seat cushions were investigated. Regression analysis results indicated that the Burger model fit the experimental creep data of the primary and secondary stages well, and the Kelvin model fit the experimental data for recovery stage well. The viscoelastic constants of derived mathematical equations can be used to describe the elastic, delayed elastic, and viscous deformation behaviors of seat cushions evaluated in this study.

The magnitude of applied creep loads had significant effects on a cushion's elastic constant if the cushion was covered with leather, but was not significant if covered with fabric. The delayed elastic constant and the damping constant related to viscous deformation significantly increased as the magnitude of applied loads increased. The damping constant related to delayed elastic deformation decreased significantly when creep loading increased from 600 to 1000 N, but the constant showed an insignificant increasing trend when the creep load increased from 250 to 600 N.

Foam cushions with coil springs in the middle had significantly greater viscoelastic constants than those without. Changing cover material from leather to fabric had no significant effect on the elastic constant of tested cushions. Cushions covered with leather tended to show greater viscous and delayed elastic deformation-related damping constants than those covered with fabric.

These conclusions might suggest that a foam cushion covered with leather and installed with coil springs in the middle can yield less permanent nonrecoverable deformation, but recover the

delayed elastic deformation more slowly than one covered with fabric and without springs. Fabric-covered cushions recovered compressive deformation faster than leather-covered ones. The Burger and Kelvin models could be used to describe the creep and recovery behavior, respectively, of a typical upholstery furniture seat cushioning system composed of foam, springs, and cover materials.

ACKNOWLEDGMENTS

Approved for publication as Journal Article No. SB 783 of the Forest and Wildlife Research Center, Mississippi State University. The project was funded by the Priority Academic Program Development (PAPD) of Jiangsu Higher Education Institutions, Jiangsu Province, China.

REFERENCES

- Bodig J, Jayne BA (1982) *Mechanics of wood and wood composites*. Van Nostrand Reinhold Company, New York, NY. 215 pp.
- BS (2000) EN 1728-2000. Domestic furniture-seating-test methods for the determination of strength and durability. British Standard, London, England.
- CNS (1989) GB 10357.3-1989. Test of mechanical properties of furniture-Strength and durability of chairs and stools. China National Standard, Beijing, China [in Chinese].
- CNS (2008) GB/T 6669-2008. Flexible cellular polymeric materials-determination of compression set. China National Standard, Beijing, China [in Chinese].
- Freund RJ, Wilson WJ (1997) *Statistical methods*. Academic Press, San Diego, CA. 371 pp.
- Izzard VG, Hadavinia H, Morris VJ, Foot PJS, Wilson L, Hewson K (2012) Compression and recovery behaviour of polyamide-6 based foams. *Polym Polym Compos* 20(5):411-423.
- Zhu HX, Mills NJ (1999) Modelling the creep of open-cell polymer foams. *J Mech Phys Solids* 47:1437-1457.